

F90F-10HB ECU

Datasheet



For advanced and challenging applications, the F90F has the highest pin count and capability of any Life Racing ECU with up to 52 outputs and 70 inputs. The F90F-HB10 ECU can be used for both DI (up to 12 cylinders in conjunction with an external GDI driver module) and / or non-DI (up to 12 cylinders) applications. With increased H-Bridge outputs this ECU will directly control 10 Half-Bridge / 5 Full-Bridge devices; e.g. GDI fuel pumps, DBW throttles, motor driven wastegates, electric thermostat, etc.

The twin processor unit uses a high speed RISC processor for code execution and an additional large FPGA for high speed engine position tracking, allowing the scheduling of code to be independent of signal patterns, increasing flexibility, efficiency and accuracy under transient conditions. This powerful combination also allows advanced control algorithms but yet remains easy to calibrate for the end user.

The F90F is designed to control complex engines including, turbocharged, supercharged, twin drive by wire, quad cam, quad VVT, variable intake, GDI, gearbox, differential and many more. The unique crank and cam sync logger allow the flexibility of controlling the most awkward trigger patterns capable of running all current known patterns and even future OEM timing wheels.

All of this hardware is packaged within a lightweight CNC billet aluminium case with Autosport connectors; designed to be installed in harsh Motorsport environments.

Processing:

- Powerful RISC CPU for advanced strategy execution
- Custom synchronous FPGA processor for engine position tracking up to 25,000rpm

Outputs:

- 52 user configurable general purpose Pulse Width Modulated power outputs, including:
 - 12 ignition coil outputs IGBT or TTL (software configurable)
 - 24 general PWM/Fuel injector outputs
 - 6 additional general PWM outputs pin shared with 6 analogue inputs (software configurable)
 - 5 full bridges also configurable as 10 half bridges or 10 PWMs

Inputs:

- 56 user configurable general purpose analogue sensor inputs, including 32 bipolar, inductive or hall effect speed / engine position inputs
- 6 additional analogue inputs pin shared with general PWM outputs (software configurable)
- 8 dedicated inputs, including:
 - 4 acoustic knock sensor inputs
 - 2 wideband (NTK) lambda sensor interface
 - 2 K-type thermocouple sensor interfaces

Interfaces:

- 100 MHz full duplex Ethernet for calibration, configuration and data download
- 2 CAN 2.0B interfaces for communication with other controllers or logging systems
- RS232 serial interface for communication with other controllers or logging systems

Memory:

- 128MB battery backed internal logging memory
- Ultra-Fast data download via Ethernet
- Time/Date stamped data via real time clock

Power Supply:

- 6V to 30V input voltage range with reverse polarity protection
- 4 regulated 5V sensor supply output with individual short circuit protection
- Software configurable (5V to 12V) sensor supply output (e.g. for 10V load cells)
- 7 Separately protected sensor and communication ground input

Physical:

- 4 Deutsch Autosport connectors with a total of 191 pins
- CNC machined sealed anodised aluminium case
- Maximum dimensions, excluding the connectors, are 177mm x 172mm x 50.5mm
- Max operating temperature 85°C
- Total mass 1113 grams

Available Upgrade Features:

- Adaptive Knock Control
- Diesel Control
- Direct Injection Pump Control
- Direct Motor Control
- Gearbox Control
- Traction Control
- Custom Security

Ordering Information:

Description	Part number
F90F-10HB ECU	ECU-B05
F90F Connector Kit	CON-A02
Adaptive Knock Control	ECU-FEAT-K
Diesel Control	ECU-FEAT-D
Direct Injection Pump Control	ECU-FEAT-I
Direct Motor Control	ECU-FEAT-E
Gearbox Control	ECU-FEAT-G
Traction Control	ECU-FEAT-T

Wiring Information:

Connector 1

Mating connector: AS616-26SA-HE

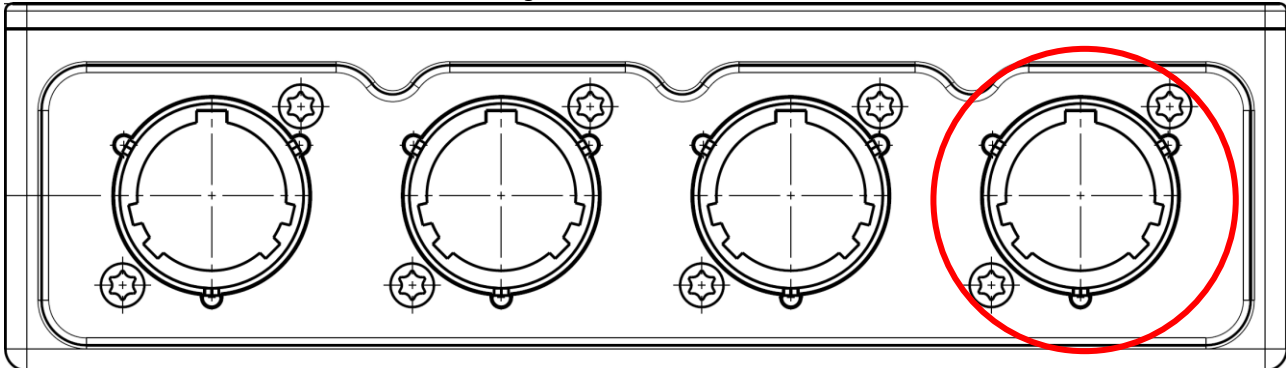

View looking at the front of an F90F highlighting connector 1 in red

Pin	Gauge	Signal Name	Software I/O assignment	Signal Notes
A	20-24AWG	POWER GROUND	N/A	ECU negative, must be engine ground and as short as possible
B	20-24AWG	POWER GROUND	N/A	ECU negative, must be engine ground and as short as possible
C	20-24AWG	POWER GROUND	N/A	ECU negative, must be engine ground and as short as possible
D	20-24AWG	POWER GROUND	N/A	ECU negative, must be engine ground and as short as possible
E	20-24AWG	POWER GROUND	N/A	ECU negative, must be engine ground and as short as possible
F	20-24AWG	POWER GROUND	N/A	ECU negative, must be engine ground and as short as possible
G	20-24AWG	POWER GROUND	N/A	ECU negative, must be engine ground and as short as possible
H	20-24AWG	IGNITION #01	IGNITION #01	Ignition coil can be "NORMAL" or "TTL" (set via software) or low-side PWM
J	20-24AWG	IGNITION #02	IGNITION #02	Ignition coil can be "NORMAL" or "TTL" (set via software) or low-side PWM
K	20-24AWG	IGNITION #03	IGNITION #03	Ignition coil can be "NORMAL" or "TTL" (set via software) or low-side PWM
L	20-24AWG	IGNITION #04	IGNITION #04	Ignition coil can be "NORMAL" or "TTL" (set via software) or low-side PWM
M	20-24AWG	IGNITION #05	IGNITION #05	Ignition coil can be "NORMAL" or "TTL" (set via software) or low-side PWM
N	20-24AWG	IGNITION #06	IGNITION #06	Ignition coil can be "NORMAL" or "TTL" (set via software) or low-side PWM
P	20-24AWG	IGNITION #07	IGNITION #07	Ignition coil can be "NORMAL" or "TTL" (set via software) or low-side PWM
R	20-24AWG	IGNITION #08	IGNITION #08	Ignition coil can be "NORMAL" or "TTL" (set via software) or low-side PWM
S	20-24AWG	IGNITION #09	IGNITION #09	Ignition coil can be "NORMAL" or "TTL" (set via software) or low-side PWM
T	20-24AWG	IGNITION #10	IGNITION #10	Ignition coil can be "NORMAL" or "TTL" (set via software) or low-side PWM
U	20-24AWG	IGNITION #11	IGNITION #11	Ignition coil can be "NORMAL" or "TTL" (set via software) or low-side PWM
V	20-24AWG	IGNITION #12	IGNITION #12	Ignition coil can be "NORMAL" or "TTL" (set via software) or low-side PWM
W	20-24AWG	BATTERY SUPPLY	N/A	ECU positive, must be as short as possible
X	20-24AWG	BATTERY SUPPLY	N/A	ECU positive, must be as short as possible
Y	20-24AWG	BATTERY SUPPLY	N/A	ECU positive, must be as short as possible
Z	20-24AWG	BATTERY SUPPLY	N/A	ECU positive, must be as short as possible
a	20-24AWG	BATTERY SUPPLY	N/A	ECU positive, must be as short as possible
b	20-24AWG	BATTERY SUPPLY	N/A	ECU positive, must be as short as possible
c	20-24AWG	BATTERY SUPPLY	N/A	ECU positive, must be as short as possible

Connector 2

Mating connector: AS616-35SN-HE

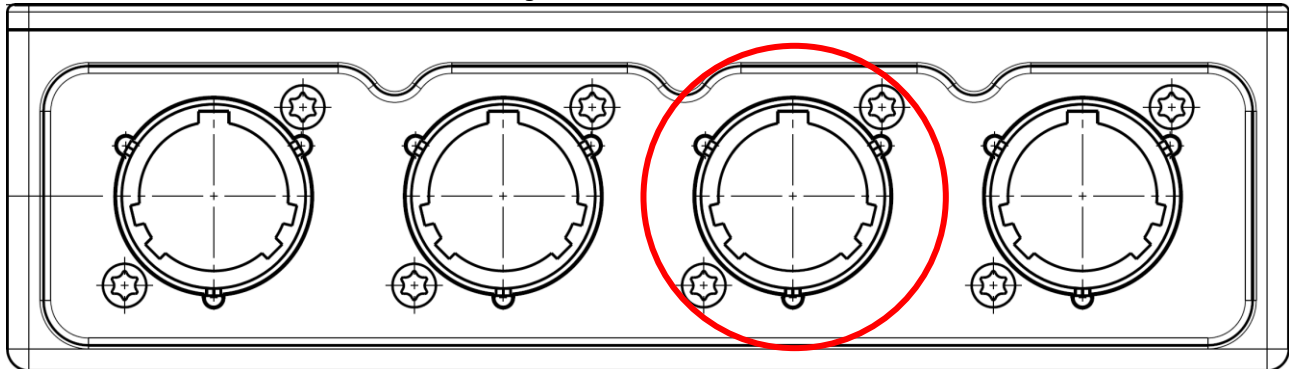

View looking at the front of an F90F highlighting connector 2 in red

Pin	Gauge	Signal Name	Software I/O assignment	Signal Notes
1	22-26AWG	5V OUT #01	N/A	Regulated 5V sensor supply rail, maximum current capability of 100mA
2	22-26AWG	5V OUT #02	N/A	Regulated 5V sensor supply rail, maximum current capability of 100mA
3	22-26AWG	10V OUT	N/A	Variable voltage supply pin, maximum current capability of 15mA
4	22-26AWG	12V OUT	N/A	Battery out
5	22-26AWG	LAN TX-	N/A	Ethernet PC communication port
6	22-26AWG	LAN TX+	N/A	Ethernet PC communication port
7	22-26AWG	LAN RX-	N/A	Ethernet PC communication port
8	22-26AWG	LAN RX+	N/A	Ethernet PC communication port
9	22-26AWG	CAN LO #01	N/A	CAN communication port 120Ω terminated
10	22-26AWG	CAN HI #01	N/A	CAN communication port 120Ω terminated
11	22-26AWG	LAMBDA V #01	LAMBDA V #01	Lambda voltage signal [Vs]
12	22-26AWG	LAMBDA I #01	N/A	Lambda current pump [Ip]
13	22-26AWG	LAMBDA GROUND	N/A	Lambda ground [Vs/Ip]
14	22-26AWG	LAMBDA V #02	LAMBDA V #02	Lambda voltage signal [Vs]
15	22-26AWG	LAMBDA I #02	N/A	Lambda current pump [Ip]
16	22-26AWG	THERMO+ #01	THERMO+ #01	Thermocouple positive [K-Type]
17	22-26AWG	THERMO- #01	N/A	Thermocouple positive [K-Type]
18	22-26AWG	THERMO+ #02	THERMO+ #02	Thermocouple positive [K-Type]
19	22-26AWG	THERMO- #02	N/A	Thermocouple positive [K-Type]
20	22-26AWG	INPUT #01 (GEN)	AN #01	Generic input; analogue or frequency; 0-5V, -5V to +5V, 47kΩ (software pullup)
21	22-26AWG	INPUT #02 (GEN)	AN #02	Generic input; analogue or frequency; 0-5V, -5V to +5V, 3kΩ (software pullup)
22	22-26AWG	SENSOR GROUND #01	N/A	Protected sensor ground
23	22-26AWG	INPUT #03 (GEN)	AN #03	Generic input; analogue or frequency; 0-5V, -5V to +5V, 3kΩ (software pullup)
24	22-26AWG	INPUT #04 (GEN)	AN #04	Generic input; analogue or frequency; 0-5V, -5V to +5V, 3kΩ (software pullup)
25	22-26AWG	SENSOR GROUND #02	N/A	Protected sensor ground
26	22-26AWG	INPUT #05 (GEN)	AN #05	Generic input; analogue or frequency; 0-5V, -5V to +5V, 3kΩ (software pullup)
27	22-26AWG	INPUT #06 (GEN)	AN #06	Generic input; analogue or frequency; 0-5V, -5V to +5V, 3kΩ (software pullup)
28	22-26AWG	SENSOR GROUND #01	N/A	Protected sensor ground
29	22-26AWG	INPUT #07 (GEN)	AN #07	Generic input; analogue or frequency; 0-5V, -5V to +5V, 3kΩ (software pullup)
30	22-26AWG	INPUT #08 (GEN)	AN #08	Generic input; analogue or frequency; 0-5V, -5V to +5V, 3kΩ (software pullup)
31	22-26AWG	SENSOR GROUND #02	N/A	Protected sensor ground
32	22-26AWG	INPUT #09 (GEN)	AN #09	Generic input; analogue or frequency; 0-5V, -5V to +5V, 3kΩ (software pullup)
33	22-26AWG	INPUT #10 (GEN)	AN #10	Generic input; analogue or frequency; 0-5V, -5V to +5V, 3kΩ (software pullup)
34	22-26AWG	SENSOR GROUND #01	N/A	Protected sensor ground
35	22-26AWG	INPUT #11 (GEN)	AN #11	Generic input; analogue or frequency; 0-5V, -5V to +5V, 3kΩ (software pullup)
36	22-26AWG	INPUT #12 (GEN)	AN #12	Generic input; analogue or frequency; 0-5V, -5V to +5V, 3kΩ (software pullup)
37	22-26AWG	SENSOR GROUND #02	N/A	Protected sensor ground
38	22-26AWG	INPUT #13 (GEN)	AN #13	Generic input; analogue or frequency; 0-5V, -5V to +5V, 3kΩ (software pullup)
39	22-26AWG	INPUT #14 (GEN)	AN #14	Generic input; analogue or frequency; 0-5V, -5V to +5V, 3kΩ (software pullup)
40	22-26AWG	SENSOR GROUND #01	N/A	Protected sensor ground

41	22-26AWG	INPUT #15 (GEN)	AN #15	Generic input; analogue or frequency; 0-5V, -5V to +5V, 3kΩ (software pullup)
42	22-26AWG	INPUT #16 (GEN)	AN #16	Generic input; analogue or frequency; 0-5V, -5V to +5V, 3kΩ (software pullup)
43	22-26AWG	SENSOR GROUND #02	N/A	Protected sensor ground
44	22-26AWG	INPUT #17 (5V)	AN #17	Analogue input 0-5V
45	22-26AWG	INPUT #18 (5V)	AN #18	Analogue input 0-5V
46	22-26AWG	SENSOR GROUND #01	N/A	Protected sensor ground
47	22-26AWG	INPUT #19 (5V)	AN #19	Analogue input 0-5V
48	22-26AWG	INPUT #20 (5V)	AN #20	Analogue input 0-5V
49	22-26AWG	SENSOR GROUND #02	N/A	Protected sensor ground
50	22-26AWG	INPUT #21 (TH)	AN #21	Thermistor input; analogue 0-5V with fixed 3kΩ pullup to 5V
51	22-26AWG	INPUT #22 (TH)	AN #22	Thermistor input; analogue 0-5V with fixed 3kΩ pullup to 5V
52	22-26AWG	SENSOR GROUND #01	N/A	Protected sensor ground
53	22-26AWG	INPUT #23 (TH)	AN #23	Thermistor input; analogue 0-5V with fixed 3kΩ pullup to 5V
54	22-26AWG	INPUT #24 (TH)	AN #24	Thermistor input; analogue 0-5V with fixed 3kΩ pullup to 5V
55	22-26AWG	SENSOR GROUND #02	N/A	Protected sensor ground

Connector 3

Mating connector: AS616-35SB-HE

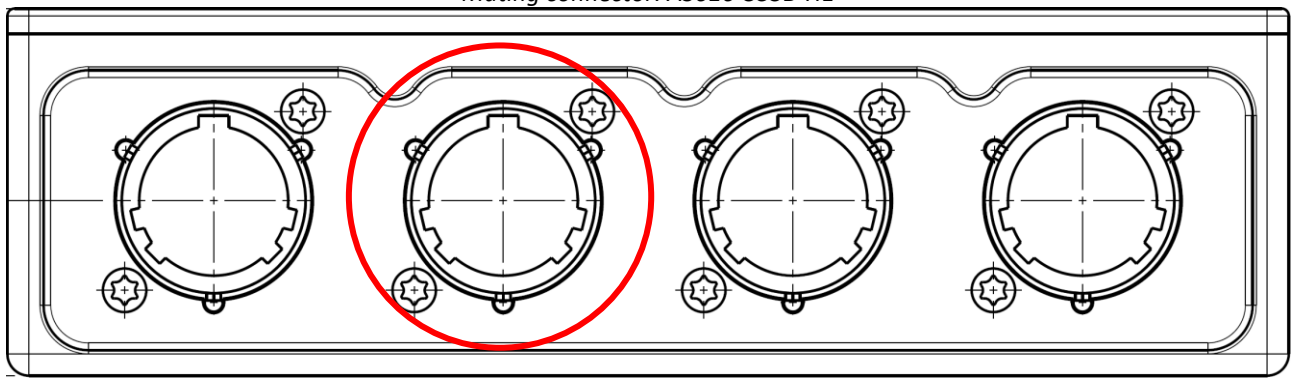

View looking at the front of an F90F highlighting connector 3 in red

Pin	Gauge	Signal Name	Software I/O assignment	Signal Notes
1	22-26AWG	5V OUT #03	N/A	Regulated 5V sensor supply rail, maximum current capability of 100mA
2	22-26AWG	5V OUT #04	N/A	Regulated 5V sensor supply rail, maximum current capability of 100mA
3	22-26AWG	CAN LO #03	N/A	CAN communication port 120Ω terminated
4	22-26AWG	CAN HI #03	N/A	CAN communication port 120Ω terminated
5	22-26AWG	INPUT #37 (5V/TH)	SLAVE 1 AN #01	Analogue input 0-5V, 47kΩ software pullup to 5V
6	22-26AWG	INPUT #38 (5V/TH)	SLAVE 1 AN #02	Analogue input 0-5V, 3kΩ software pullup to 5V
7	22-26AWG	SENSOR GROUND #03	N/A	Protected sensor ground
8	22-26AWG	INPUT #39 (5V/TH)	SLAVE 1 AN #03	Analogue input 0-5V, 3kΩ software pullup to 5V
9	22-26AWG	INPUT #40 (5V/TH)	SLAVE 1 AN #04	Analogue input 0-5V, 3kΩ software pullup to 5V
10	22-26AWG	SENSOR GROUND #04	N/A	Protected sensor ground
11	22-26AWG	INPUT #41 (5V/TH)	SLAVE 1 AN #05	Analogue input 0-5V, 3kΩ software pullup to 5V
12	22-26AWG	INPUT #42 (5V/TH)	SLAVE 1 AN #06	Analogue input 0-5V, 3kΩ software pullup to 5V
13	22-26AWG	SENSOR GROUND #03	N/A	Protected sensor ground
14	22-26AWG	INPUT #43 (5V/TH)	SLAVE 1 AN #07	Analogue input 0-5V, 3kΩ software pullup to 5V
15	22-26AWG	INPUT #44 (5V/TH)	SLAVE 1 AN #08	Analogue input 0-5V, 3kΩ software pullup to 5V
16	22-26AWG	SENSOR GROUND #04	N/A	Protected sensor ground
17	22-26AWG	INPUT #45 (GEN)	SLAVE 1 AN #09	Generic input; analogue or frequency; 0-5V, -5V to +5V, 3kΩ (software pullup)
18	22-26AWG	INPUT #46 (GEN)	SLAVE 1 AN #10	Generic input; analogue or frequency; 0-5V, -5V to +5V, 3kΩ (software pullup)
19	22-26AWG	SENSOR GROUND #03	N/A	Protected sensor ground
20	22-26AWG	INPUT #47 (GEN)	SLAVE 1 AN #11	Generic input; analogue or frequency; 0-5V, -5V to +5V, 3kΩ (software pullup)
21	22-26AWG	INPUT #48 (GEN)	SLAVE 1 AN #12	Generic input; analogue or frequency; 0-5V, -5V to +5V, 3kΩ (software pullup)
22	22-26AWG	SENSOR GROUND #04	N/A	Protected sensor ground
23	22-26AWG	INPUT #49 (5V/TH)	SLAVE 1 AN #13	Analogue input 0-5V, 3kΩ software pullup to 5V
24	22-26AWG	INPUT #50 (5V/TH)	SLAVE 1 AN #14	Analogue input 0-5V, 3kΩ software pullup to 5V

25	22-26AWG	SENSOR GROUND #03	N/A	Protected sensor ground
26	22-26AWG	INPUT #51 (5V/TH)	SLAVE 1 AN #15	Analogue input 0-5V, 3kΩ software pullup to 5V
27	22-26AWG	INPUT #52 (5V/TH)	SLAVE 1 AN #16	Analogue input 0-5V, 3kΩ software pullup to 5V
28	22-26AWG	SENSOR GROUND #04	N/A	Protected sensor ground
29	22-26AWG	INPUT #53 (5V)	SLAVE 1 AN #17	Analogue input 0-5V
30	22-26AWG	INPUT #54 (5V)	SLAVE 1 AN #18	Analogue input 0-5V
31	22-26AWG	SENSOR GROUND #03	N/A	Protected sensor ground
32	22-26AWG	INPUT #55 (5V)	SLAVE 1 AN #19	Analogue input 0-5V
33	22-26AWG	INPUT #56 (5V)	SLAVE 1 AN #20	Analogue input 0-5V
34	22-26AWG	SENSOR GROUND #04	N/A	Protected sensor ground
35	22-26AWG	INPUT #57 (TH)	SLAVE 1 AN #21	Thermistor input; analogue 0-5V with fixed 3kΩ pullup to 5V
36	22-26AWG	INPUT #58 (TH)	SLAVE 1 AN #22	Thermistor input; analogue 0-5V with fixed 3kΩ pullup to 5V
37	22-26AWG	SENSOR GROUND #03	N/A	Protected sensor ground
38	22-26AWG	KNOCK #01 ⁽¹⁾	KNOCK #01	Knock sensor input
39	22-26AWG	KNOCK #02 ⁽¹⁾	KNOCK #02	Knock sensor input
40	22-26AWG	KNOCK GROUND	N/A	Knock sensor ground
41	22-26AWG	KNOCK #03 ⁽¹⁾	KNOCK #03	Knock sensor input
42	22-26AWG	KNOCK #04 ⁽¹⁾	KNOCK #04	Knock sensor input
43	22-26AWG	KNOCK GROUND	N/A	Knock sensor ground
44	22-26AWG	DO NOT CONNECT	N/A	LR internal use
45	22-26AWG	DO NOT CONNECT	N/A	LR internal use
46	22-26AWG	SENSOR GROUND #03	N/A	Protected sensor ground
47	22-26AWG	INPUT #59 (TH)	SLAVE 1 AN #23	Thermistor input; analogue 0-5V with fixed 3kΩ pullup to 5V
48	22-26AWG	INPUT #60 (TH)	SLAVE 1 AN #24	Thermistor input; analogue 0-5V with fixed 3kΩ pullup to 5V
49	22-26AWG	SENSOR GROUND #03	N/A	Protected sensor ground
50	22-26AWG	INPUT #61 (5V)	SLAVE 1 AN #25	Analogue input 0-5V
51	22-26AWG	INPUT #62 (5V)	SLAVE 1 AN #26	Analogue input 0-5V
52	22-26AWG	SENSOR GROUND #04	N/A	Protected sensor ground
53	22-26AWG	INPUT #63 (5V)	SLAVE 1 AN #27	Analogue input 0-5V
54	22-26AWG	INPUT #64 (5V)	SLAVE 1 AN #28	Analogue input 0-5V
55	22-26AWG	SENSOR GROUND #04	N/A	Protected sensor ground

Connector 4

Mating connector: AS616-35SD-HE

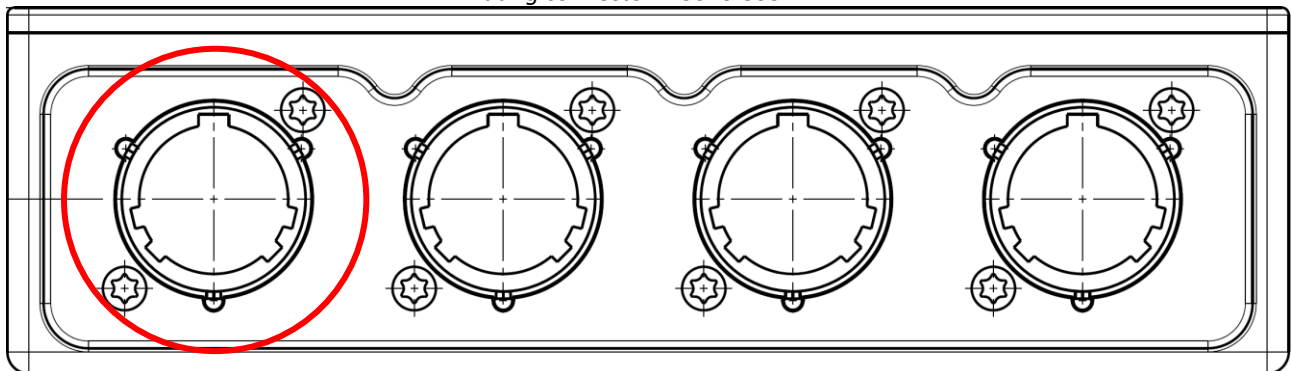

View looking at the front of an F90F highlighting connector 4 in red

Pin	Gauge	Signal Name	Software I/O assignment	Signal Notes
1	22-26AWG	FUEL #01	FUEL #01	Port fuel injector or low-side PWM 10A peak
2	22-26AWG	FUEL #02	FUEL #02	Port fuel injector or low-side PWM 10A peak
3	22-26AWG	FUEL #03	FUEL #03	Port fuel injector or low-side PWM 10A peak
4	22-26AWG	FUEL #04	FUEL #04	Port fuel injector or low-side PWM 10A peak
5	22-26AWG	FUEL #05	FUEL #05	Port fuel injector or low-side PWM 10A peak
6	22-26AWG	FUEL #06	FUEL #06	Port fuel injector or low-side PWM 10A peak
7	22-26AWG	FUEL #07	FUEL #07	Port fuel injector or low-side PWM 10A peak
8	22-26AWG	FUEL #08	FUEL #08	Port fuel injector or low-side PWM 10A peak
9	22-26AWG	FUEL #09	FUEL #09	Port fuel injector or low-side PWM 10A peak

10	22-26AWG	FUEL #10	FUEL #10	Port fuel injector or low-side PWM 10A peak
11	22-26AWG	FUEL #11	FUEL #11	Port fuel injector or low-side PWM 10A peak
12	22-26AWG	FUEL #12	FUEL #12	Port fuel injector or low-side PWM 10A peak
13	22-26AWG	FUEL #13	FUEL #13	Port fuel injector or low-side PWM 10A peak
14	22-26AWG	FUEL #14	FUEL #14	Port fuel injector or low-side PWM 10A peak
15	22-26AWG	FUEL #15	FUEL #15	Port fuel injector or low-side PWM 10A peak
16	22-26AWG	FUEL #16	FUEL #16	Port fuel injector or low-side PWM 10A peak
17	22-26AWG	FUEL #17	FUEL #17	Port fuel injector or low-side PWM 10A peak
18	22-26AWG	FUEL #18	FUEL #18	Port fuel injector or low-side PWM 10A peak
19	22-26AWG	FUEL #19	FUEL #19	Port fuel injector or low-side PWM 10A peak
20	22-26AWG	FUEL #20	FUEL #20	Port fuel injector or low-side PWM 10A peak
21	22-26AWG	FUEL #21	FUEL #21	Port fuel injector or low-side PWM 10A peak
22	22-26AWG	FUEL #22	FUEL #22	Port fuel injector or low-side PWM 10A peak
23	22-26AWG	FUEL #23	FUEL #23	Port fuel injector or low-side PWM 10A peak
24	22-26AWG	FUEL #24	FUEL #24	Port fuel injector or low-side PWM 10A peak
25	22-26AWG	H-BRIDGE #04	H-BRIDGE #04	H-bridge, low-side PWM or full bridge ⁽¹⁾ , 20A peak
26	22-26AWG	H-BRIDGE #03	H-BRIDGE #03	H-bridge, low-side PWM or full bridge ⁽¹⁾ , 20A peak
27	22-26AWG	H-BRIDGE #01	H-BRIDGE #01	H-bridge, low-side PWM or full bridge ⁽¹⁾ , 20A peak
28	22-26AWG	H-BRIDGE #02	H-BRIDGE #02	H-bridge, low-side PWM or full bridge ⁽¹⁾ , 20A peak
29	22-26AWG	H-BRIDGE #08	SLAVE 1 OUT #26	H-bridge, low-side PWM or full bridge ⁽¹⁾ , 20A peak
30	22-26AWG	H-BRIDGE #07	SLAVE 1 OUT #25	H-bridge, low-side PWM or full bridge ⁽¹⁾ , 20A peak
31	22-26AWG	H-BRIDGE #05	H-BRIDGE #05	H-bridge, low-side PWM or full bridge ⁽¹⁾ , 20A peak
32	22-26AWG	H-BRIDGE #06	H-BRIDGE #06	H-bridge, low-side PWM or full bridge ⁽¹⁾ , 20A peak
33	22-26AWG	PWM #01 / INPUT #29 (5V)	PWM #01 / INPUT #29	low-side PWM 10A or Analogue input 0-5V (software selectable)
34	22-26AWG	PWM #02 / INPUT #30 (5V)	PWM #02 / INPUT #30	low-side PWM 10A or Analogue input 0-5V (software selectable)
35	22-26AWG	PWM #03 / INPUT #31 (5V)	PWM #03 / INPUT #31	low-side PWM 10A or Analogue input 0-5V (software selectable)
36	22-26AWG	PWM #04 / INPUT #32 (5V)	PWM #04 / INPUT #32	low-side PWM 10A or Analogue input 0-5V (software selectable)
37	22-26AWG	PWM #05 / INPUT #33 (5V)	PWM #05 / INPUT #33	low-side PWM 10A or Analogue input 0-5V (software selectable)
38	22-26AWG	PWM #06 / INPUT #34 (5V)	PWM #06 / INPUT #34	low-side PWM 10A or Analogue input 0-5V (software selectable)
39	22-26AWG	H-BRIDGE #10	SLAVE 1 OUT #28	H-bridge, low-side PWM or full bridge ⁽¹⁾ , 20A peak
40	22-26AWG	H-BRIDGE #09	SLAVE 1 OUT #27	H-bridge, low-side PWM or full bridge ⁽¹⁾ , 20A peak
41	22-26AWG	INPUT #25 (5V)	INPUT #25	Analogue input 0-5V
42	22-26AWG	INPUT #26 (5V)	INPUT #26	Analogue input 0-5V
43	22-26AWG	INPUT #27 (5V)	INPUT #27	Analogue input 0-5V
44	22-26AWG	INPUT #28 (5V)	INPUT #28	Analogue input 0-5V
45	22-26AWG	DO NOT CONNECT	N/A	LR internal use
46	22-26AWG	DO NOT CONNECT	N/A	LR internal use
47	22-26AWG	DO NOT CONNECT	N/A	LR internal use
48	22-26AWG	DO NOT CONNECT	N/A	LR internal use
49	22-26AWG	5V OUT #01	N/A	Regulated 5V sensor supply rail, maximum current capability of 100mA
50	22-26AWG	12V OUT	N/A	Battery out
51	22-26AWG	DO NOT CONNECT	N/A	LR internal use
52	22-26AWG	DO NOT CONNECT	N/A	LR internal use
53	22-26AWG	RS232 TX	N/A	RS232 transmit
54	22-26AWG	SENSOR GROUND #01	N/A	Protected sensor ground
55	22-26AWG	RS232 RX	N/A	RS232 receive

Footnotes:

⁽¹⁾Relevant upgrade feature must be enabled

Dimensions:

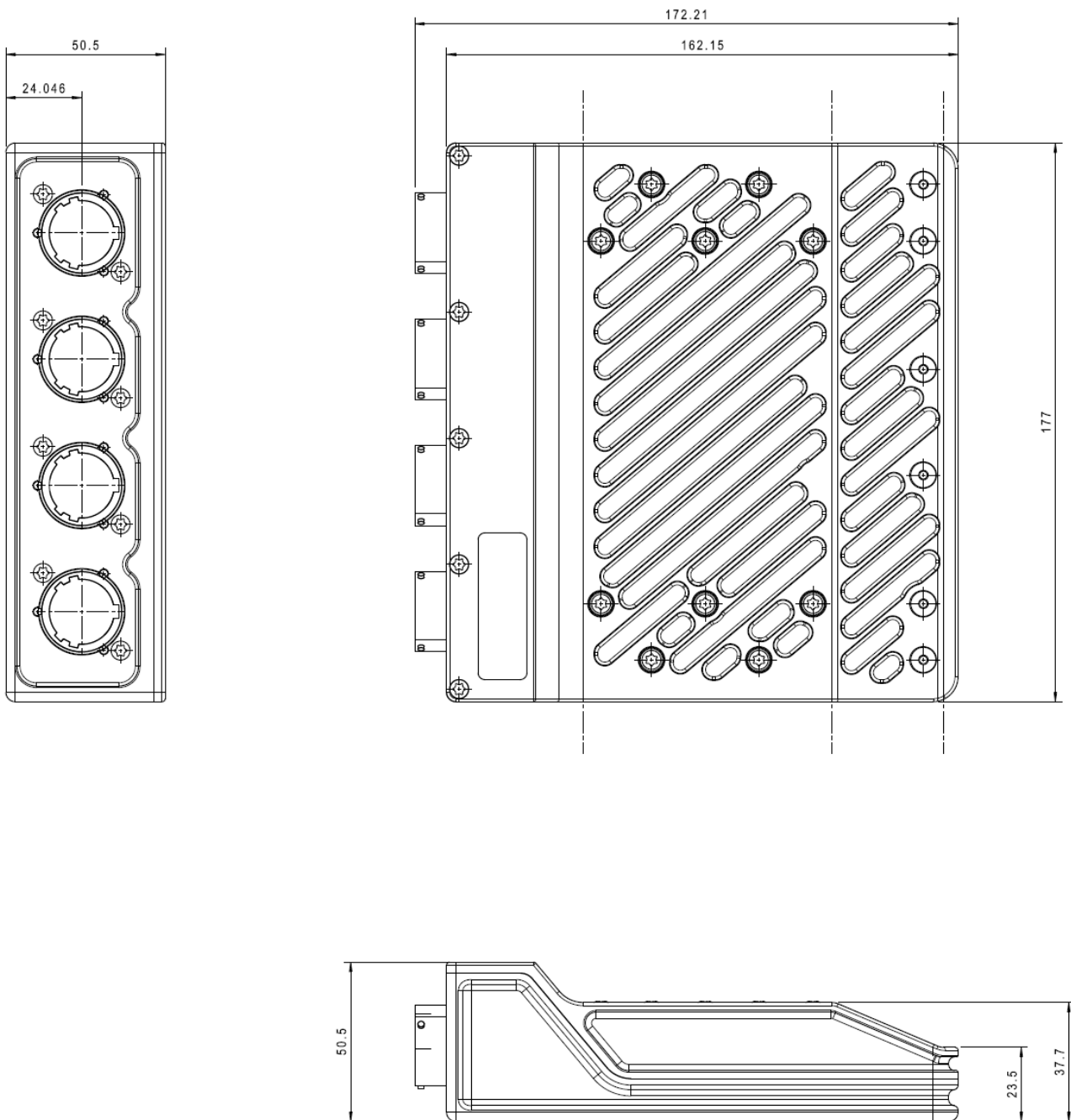

Warranty and Servicing:

- This equipment comes with a 1 year warranty against manufacturing defects and failures however misuse or damage will not be covered under warranty.
- Warranty may be extended on an annual basis via a system refurbishment scheme.
- This ECU contains a battery which can be returned to Life Racing for a replacement, a charge may be made for this service.