

F88GDi4 V2 Datasheet



The F88GDi4 ECU sets the benchmark for integrated direct injection engine management. Based on the F88 architecture the GDi4 is by no means a compromise. This control unit features efficient use of its IO complement specifically designed for a modern 4 cylinder engine yet cost effective for GDI and CI applications that do not require the complexity of the F90 series controllers.

This twin processor unit uses a high speed RISC processor for code execution and an additional large FPGA for high speed engine position tracking, allowing scheduling code to be independent of signal patterns thus increasing flexibility, efficiency and accuracy under transient conditions. This powerful combination also allows advanced control algorithms yet remains easy to calibrate for the end user.

The F88GDi4 is designed to directly drive all solenoid GD injectors including parts from Ford, GM and Bosch (including Bosch Motorsport types) without the need for an external driver box. Standard strategies include, turbocharged, supercharged, drive by wire, twin cam, twin vvt, vtec, gearbox, differential and many more. The internal data logging coupled with a unique crank and cam sync logger allows detailed analysis of input, control signals and fault diagnosis.

This powerful hardware is packaged within a lightweight high pressure die cast aluminium case designed to be installed in harsh Motorsport environments.

The V2 spec applies to all F88GDi4 units with serial numbers higher than 17000.

Processing:

- Powerful RISC CPU for advanced strategy execution
- Custom synchronous FPGA processor for engine position tracking up to 25,000rpm

Outputs:

- 24 user configurable general purpose Pulse Width Modulated power outputs, including:
- 4 ignition coil outputs IGBT or TTL (Software configurable)
- 10 general PWM/Port injector outputs
- 2 inductive load/general PWM outputs
- 4 dedicated GDI injector drive outputs (Software configurable power settings)
- 3 full bridges also configurable as 6 half bridges or 6 PWMs

Inputs:

- 24 user configurable general purpose analogue sensor inputs, including 16 bipolar, inductive or hall effect speed / engine position inputs
- 5 dedicated inputs, including:
- 2 acoustic knock sensor inputs
- 1 wideband (NTK) lambda sensor interface
- 1 K-type thermocouple sensor interface

Interfaces:

- 100 MHz full duplex Ethernet for calibration, configuration and data download
- 3 CAN 2.0B interfaces for communication with other controllers or logging systems
- RS232 serial interface for communication with other controllers or logging systems

Memory:

- 64MB battery backed internal logging memory
- Ultra-Fast data download via Ethernet
- Time/Date stamped data via real time clock

Power Supply:

- 6V to 32V input voltage range with reverse polarity protection
- 2 regulated 5V sensor supply output with individual short circuit protection
- 5 Separately protected sensor and communication ground input

Physical:

- 88 way Bosch / AMP sealed connector
- Sealed high pressure die cast black powder coated aluminium case
- Maximum dimension including the connector is 183mm x 125mm x 36mm
- Max operating temperature 85°C
- Total mass 520 grams

Available Upgrade Features:

- Adaptive Knock Control
- Diesel Control
- Gearbox Control
- Traction Control
- Custom Security

Ordering Information:

Description	Part number
F88GDi4 ECU	ECU-C01
88Way Connector Kit	CON-B01
Adaptive Knock Control	ECU-FEAT-K
Diesel Control	ECU-FEAT-D
Gearbox Control	ECU-FEAT-G
Traction Control	ECU-FEAT-T

Wiring Information:

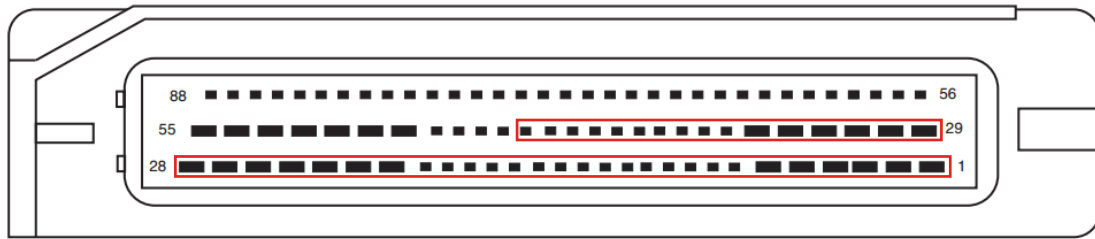

View looking into the 88 way connector highlighting pins 1-44 in red

Pin	Gauge	Signal Name	Signal Notes
1	18AWG	POWER GROUND	ECU negative, must be engine ground and as short as possible
2	20AWG	IGNITION #08	Ignition coil can be "NORMAL" or "TTL" (set via software) or low-side PWM
3	20AWG	IGNITION #07	Ignition coil can be "NORMAL" or "TTL" (set via software) or low-side PWM
4	20AWG	IGNITION #06	Ignition coil can be "NORMAL" or "TTL" (set via software) or low-side PWM
5	20AWG	IGNITION #05	Ignition coil can be "NORMAL" or "TTL" (set via software) or low-side PWM
6	22AWG	FUEL #10	Port fuel injector or low-side PWM 10A peak
7	24AWG	KNOCK #02 ⁽¹⁾	Knock sensor input
8	24AWG	INPUT #16	Generic input; analogue or frequency; 0-5V, -5V to +5V, 3kΩ (software pullup)
9	24AWG	INPUT #14	Generic input; analogue or frequency; 0-5V, -5V to +5V, 3kΩ (software pullup)
10	24AWG	INPUT #12	Generic input; analogue or frequency; 0-5V, -5V to +5V, 3kΩ (software pullup)
11	24AWG	INPUT #10	Generic input; analogue or frequency; 0-5V, -5V to +5V, 3kΩ (software pullup)
12	20AWG	H-BRIDGE #5	H-bridge, low-side or full bridge PWM, 20A peak
13	20AWG	H-BRIDGE #6	H-bridge, low-side or full bridge PWM, 20A peak
14	24AWG	INPUT #07	Generic input; analogue or frequency; 0-5V, -5V to +5V, 3kΩ (software pullup)
15	24AWG	INPUT #05	Generic input; analogue or frequency; 0-5V, -5V to +5V, 3kΩ (software pullup)
16	24AWG	INPUT #03	Generic input; analogue or frequency; 0-5V, -5V to +5V, 3kΩ (software pullup)
17	24AWG	INPUT #01	Generic input; analogue or frequency; 0-5V, -5V to +5V, 47kΩ (software pullup)
18	24AWG	LAMBDA V #01	Lambda voltage signal [Vs]
19	24AWG	INPUT #21	Thermistor input; analogue 0-5V with fixed 3kΩ pullup to 5V
20	22AWG	FUEL #15	Port fuel injector or low-side PWM 10A peak
21	24AWG	RS232 TX	RS232 transmit
22	22AWG	FUEL #07	Port fuel injector or low-side PWM 10A peak
23	22AWG	FUEL #05	NOT FOR INJECTION. Low-side PWM 10A peak with recirculating diode, for VVT solenoid control
24	20AWG	GDI #04+	Direct injector positive must be twisted with matching negative to each injector
25	20AWG	GDI #03+	Direct injector positive must be twisted with matching negative to each injector
26	20AWG	GDI #02+	Direct injector positive must be twisted with matching negative to each injector
27	20AWG	GDI #01+	Direct injector positive must be twisted with matching negative to each injector
28	18AWG	POWER GROUND	ECU negative, must be engine ground and as short as possible
29	18AWG	POWER GROUND	ECU negative, must be engine ground and as short as possible
30	22AWG	FUEL #14	Port fuel injector or low-side PWM 10A peak
31	22AWG	FUEL #13	Port fuel injector or low-side PWM 10A peak
32	20AWG	FUEL #12 / GDI PUMP-	NOT FOR INJECTION. GDI pump negative or low-side PWM 20A peak
33	22AWG	FUEL #11	Port fuel injector or low-side PWM 10A peak
34	22AWG	FUEL #09	Port fuel injector or low-side PWM 10A peak
35	24AWG	KNOCK #01 ⁽¹⁾	Knock sensor input
36	24AWG	INPUT #15	Generic input; analogue or frequency; 0-5V, -5V to +5V, 3kΩ (software pullup)
37	24AWG	INPUT #13	Generic input; analogue or frequency; 0-5V, -5V to +5V, 3kΩ (software pullup)
38	24AWG	INPUT #11	Generic input; analogue or frequency; 0-5V, -5V to +5V, 3kΩ (software pullup)
39	24AWG	INPUT #09	Generic input; analogue or frequency; 0-5V, -5V to +5V, 3kΩ (software pullup)
40	24AWG	THERMO- #01	Thermocouple negative [K-Type]
41	24AWG	INPUT #08	Generic input; analogue or frequency; 0-5V, -5V to +5V, 3kΩ (software pullup)
42	24AWG	INPUT #06	Generic input; analogue or frequency; 0-5V, -5V to +5V, 3kΩ (software pullup)
43	24AWG	INPUT #04	Generic input; analogue or frequency; 0-5V, -5V to +5V, 3kΩ (software pullup)
44	24AWG	INPUT #02	Generic input; analogue or frequency; 0-5V, -5V to +5V, 3kΩ (software pullup)

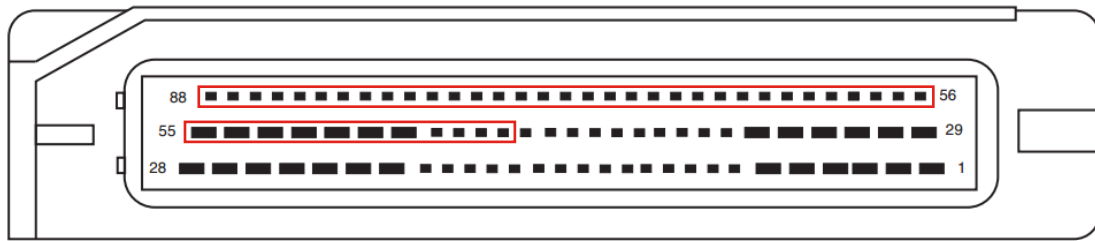

View looking into the 88 way connector highlighting pins 45-88 in red

Pin	Gauge	Signal Name	Signal Notes
45	24AWG	CAN LO #03	CAN communication port 120Ω terminated
46	24AWG	INPUT #22	Thermistor input; analogue 0-5V with fixed 3kΩ pullup to 5V
47	22AWG	FUEL #16	Port fuel injector or low-side PWM 10A peak
48	24AWG	RS232 RX	RS232 receive
49	22AWG	FUEL #08	Port fuel injector or low-side PWM 10A peak
50	22AWG	FUEL #06	NOT FOR INJECTION. Low-side PWM 10A peak with recirculating diode, for VVT solenoid control
51	20AWG	GDI #04 -	Direct injector negative must be twisted with matching positive to each injector
52	20AWG	GDI #03 -	Direct injector negative must be twisted with matching positive to each injector
53	20AWG	GDI #02 -	Direct injector negative must be twisted with matching positive to each injector
54	20AWG	GDI #01 -	Direct injector negative must be twisted with matching positive to each injector
55	18AWG	POWER GROUND	ECU negative, must be engine ground and as short as possible
56	18AWG	BATTERY SUPPLY	ECU positive, must be as short as possible
57	18AWG	BATTERY SUPPLY	ECU positive, must be as short as possible
58	20AWG	H-BRIDGE #01 / GDI PUMP+	GDI pump positive, low-side or full bridge PWM, 20A peak
59	20AWG	H-BRIDGE #02	H-bridge, low-side or full bridge PWM, 20A peak
60	20AWG	H-BRIDGE #03 / DBW+	H-bridge, low-side or full bridge PWM, 20A peak
61	20AWG	H-BRIDGE #04 / DBW-	H-bridge, low-side or full bridge PWM, 20A peak
62	-	DO NOT CONNECT	LR Internal use only
63	24AWG	5V OUT #02	Regulated 5V sensor supply rail, maximum current capability of 100mA
64	24AWG	5V OUT #01	Regulated 5V sensor supply rail, maximum current capability of 100mA
65	24AWG	KNOCK GROUND ⁽¹⁾	Knock sensor ground
66	24AWG	INPUT #20 / KNOCK #04 ⁽¹⁾	Analogue input 0-5V or knock sensor input (set via software)
67	24AWG	SENSOR GROUND #02	Protected sensor ground
68	24AWG	INPUT #19 / KNOCK #03 ⁽¹⁾	Analogue input 0-5V or knock sensor input (set via software)
69	24AWG	SENSOR GROUND #01	Protected sensor ground
70	24AWG	THERMO + #01	Thermocouple positive [K-Type]
71	24AWG	INPUT #18	Analogue input 0-5V
72	24AWG	SENSOR GROUND #02	Protected sensor ground
73	24AWG	INPUT #17	Analogue input 0-5V
74	24AWG	SENSOR GROUND #01	Protected sensor ground
75	24AWG	CAN HI #03	CAN communication port 120Ω terminated
76	24AWG	LAMBDA I #01	Lambda current pump [Ip]
77	24AWG	LAMBDA GROUND	Lambda ground [Vs/Ip]
78	24AWG	COMMS GROUND	Protected communication ground
79	24AWG	CAN LO #02	CAN communication port 120Ω terminated
80	24AWG	CAN HI #02	CAN communication port 120Ω terminated
81	24AWG	CAN LO #01	CAN communication port 120Ω terminated
82	24AWG	CAN HI #01	CAN communication port 120Ω terminated
83	24AWG	INPUT #24	Thermistor input; analogue 0-5V with fixed 3kΩ pullup to 5V
84	24AWG	INPUT #23	Thermistor input; analogue 0-5V with fixed 3kΩ pullup to 5V
85	24AWG	LAN RX+	Ethernet PC communication port
86	24AWG	LAN RX-	Ethernet PC communication port
87	24AWG	LAN TX+	Ethernet PC communication port
88	24AWG	LAN TX-	Ethernet PC communication port

Footnotes:

⁽¹⁾Relevant upgrade feature must be enabled to use signal

Dimensions:

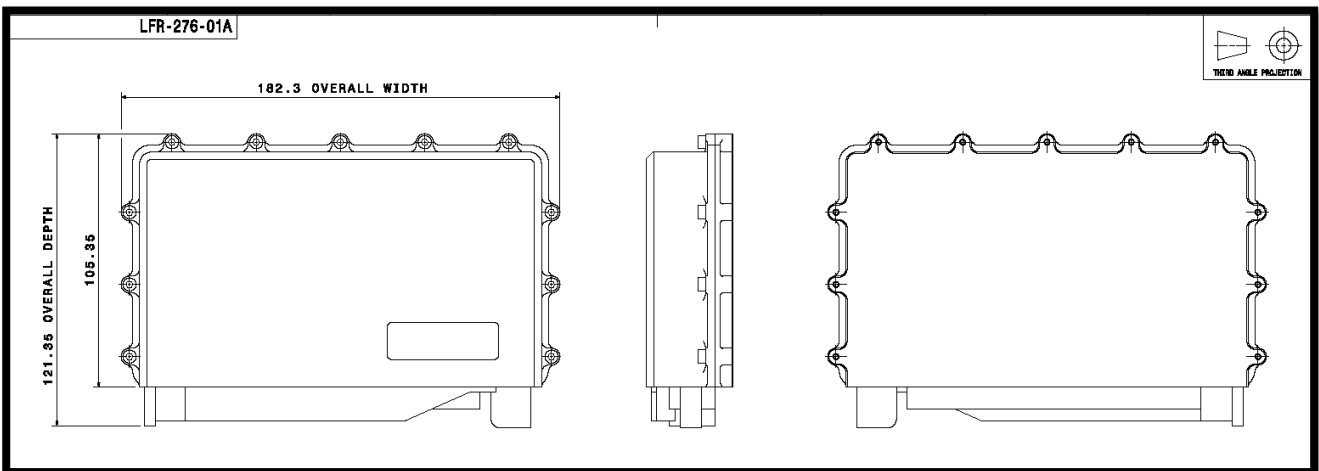
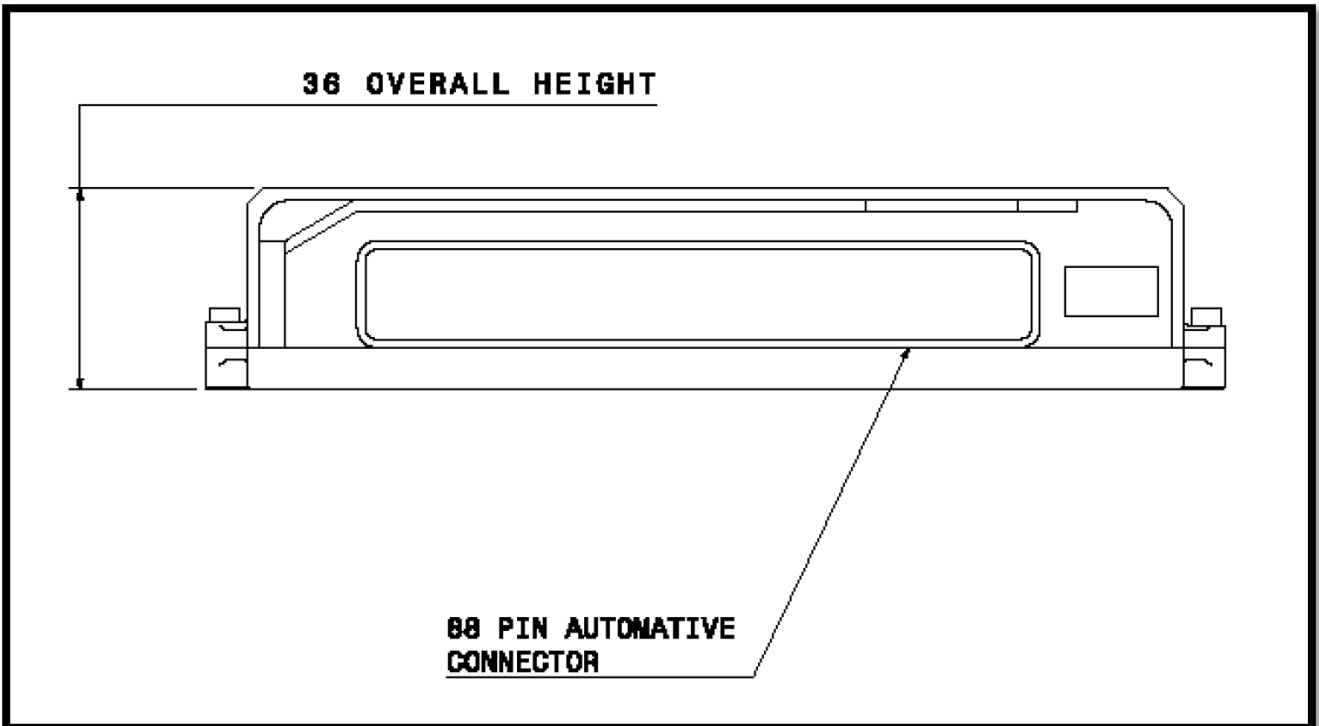

Warranty and Servicing:

- This equipment comes with a 1 year warranty against manufacturing defects and failures however misuse or damage will not be covered under warranty.
- Warranty may be extended on an annual basis via a system refurbishment scheme.
- This ECU contains a battery which can be returned to Life Racing for a replacement, a charge may be made for this service.